

REAL[®] 8100



Chair with electric function, for X-ray

USER and CARE INSTRUCTIONS

Article No:

1811

The REAL-chair has replaceable components, accessories, and functions with setting options which allow individual adjustment. The chair must only be used by the person and the purpose for which it is intended. The chair is designed for indoor use and must not be exposed to water, other liquids or chemicals. The chair must not be exposed to intensive sunlight for any length of time. The chair must not be fitted with accessories or components other than those approved by Mercado Medic AB Repair and other technical actions must only be carried out by personnel authorised by Mercado Medic AB. Read this user instruction carefully before using the chair.

Class

REAL 8100 is classified as protection class II, internal battery. REAL 8100 is classified as protection type B. REAL 8100 has been EMC-tested and proven in accordance with EN 60601-1-1 and EN 60601-1-2, and must therefore be used in accordance with our user and care instructions.

Mobile telephones or other RF communication equipment can interfere with the REAL 8100.

Max. user weight: 150 kg.

The chair must be transported in designated boxes on pallets, and must be stored indoors at min. +10°C.

Only electrical equipment from Mercado Medic AB is permitted for use with the REAL 8100.

PLEASE NOTE! The electric functions on the electric chair may only be used a maximum of 10% of the time (max 6 min/h).

If this limit is exceeded the chair can be damaged. This symbol warns of the danger of crushing. 

PLEASE NOTE! Only the person seated in the chair is allowed any contact with the chair whilst using electrical functions.

Seat height

The seat height is adjusted using a remote control. The remote control is equipped with either two buttons (the chair only has electric raising/lowering) or eight buttons (in addition to electric raising/lowering, the chair also has electric seat tilt(3/7) and electric brake(4)).

To raise the seat – press the left button on the remote control (top row). To lower the seat – press the right button on the remote control (top row). **PLEASE NOTE!** If the remote control has more than two buttons (eight buttons with additional electric functions), the raising/lowering functions are located in the second top row(2/6). The chair can also be equipped with an electric backrest tilt mechanism which is controlled using the remote(1/5).

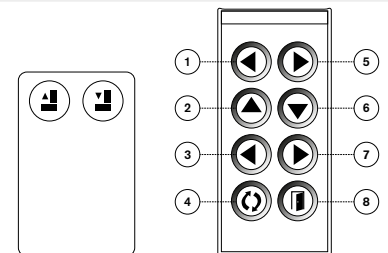

Remote control units

Seat tilting

Seat tilt adjustment is available in two models: crank or electrically regulated. For the crank regulated seat, the angle is adjusted using the knob (9).

The tilt increments (+15°/-8°) can be adjusted using the nuts(10).

Electric tilt adjustment can be regulated using the remote control.

Press the left button (3) to incline the seat forwards, and the right button (7) to incline the seat backwards.

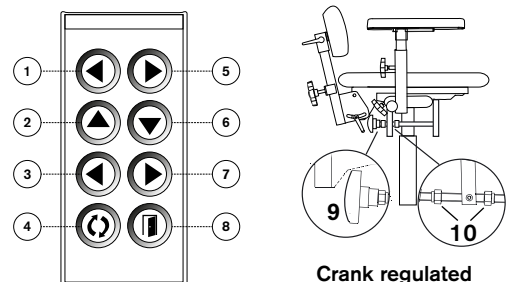

Crank regulated

Brake

The brake is regulated using the foot pedal, the handbrake lever or electrically (via the remote control). To lock: press the foot pedal (11) located to the left of the brake shaft, until the brake foot touches the floor and has locked. To brake the chair using the handbrake lever – move this backwards until the brake foot touches the floor and is locked. The handbrake lever may be positioned on either side of the chair. If the chair has an electric brake – press the lowest button on the left of the remote control (4) to brake or to release the brake. **Attention!** The brake must always be locked when sitting down and standing up from the chair. The brake must be checked regularly. If worn, replace the rubber brake feet (12). The brake function may be less effective on uneven surfaces. To correctly calibrate the chair with respect to the investigative equipment, place the brake leg in the pre-installed positioning cups in the clinic floor.

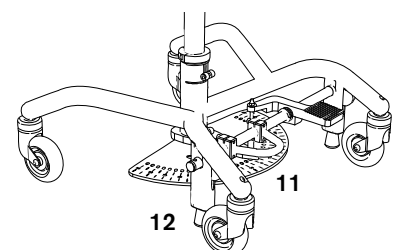

Protractor with rotation release

The REAL 8100 can be rotated. Rotation is released by pressing the foot regulator (placed on the right of the brake shaft on the rear of the frame). Rotate the seat to the desired angle and release the pressure on the foot regulator, locking the rotation at the desired angle on the protractor.

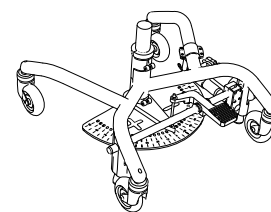

Backrest

One model is available with X-ray back mechanism. The back is available in one low design (33x16 cm), and two high (high back with neck rest in Makrolon, and high back in carbon fibre). The back mechanism has separate regulators for adjusting the height (1) and angle (2). Loosen the knob, set the desired height/angle and the lock using the knob. The angle of the X-ray back incline is also adjusted using the knob (3). The high backrest with neck rest made of Makrolon has a height-adjustable cushion (4).

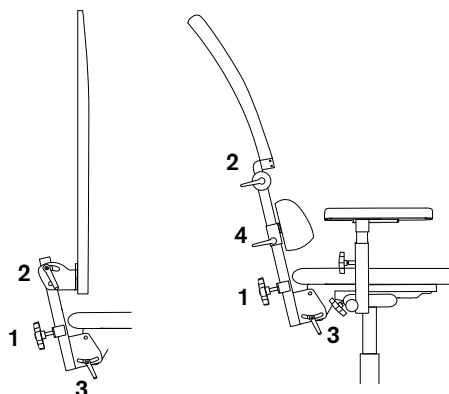

Collapsible arm rests

The arm rests can be adjusted in height and width and can be folded back. The height is adjusted using the knob (5). To lower the arm rest, loosen the knob. To raise the arm rest, lift the arm rest to the desired height and then lock using the knob. The width is adjusted using the knob (6). Loosen the knob, adjust and lock. The arm rest is folded back using the knob (7). Pull out and fold back. The device locks automatically when the arm rest falls back to a vertical position. Automatic locking can be prevented by turning the knob (3) a quarter turn.

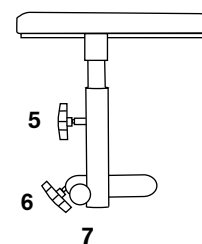

Cleaning, maintenance and charging

The chair must be wiped clean and kept dirt and dust free. Use a cloth and foam cleaner. The seat, back support and other upholstered parts are not made from sealed materials for functional reasons. For hygienic reasons, whenever the upholstery is replaced, the seat and upholstery filling must also be replaced. The electric lifting device must be checked regularly for dirt and dust: move the seat up to the highest position. Clean with a dry cloth. Do not use water or solvents. Lubricate the cylinder with a thin film of teflon- or silicon-based grease. These are not as messy as mineral-based lubricants. Tools, grease, etc., for care of the chair can be ordered from Mercado Medic AB. Use only battery charger REAL 9000 model 2240-12V, item no. 802289 when charging the chair. The battery should be charged regularly; if possible once a day. It is important that the battery that it is never completely discharged. This extends the lifetime of the battery. Connect the charger contact (1) to the jack on the box by the toggle switch for raising and lowering the chair. Connect the charger's plug to a wall socket. The light on the charger indicates that the battery is charging. When the light changes from yellow to green the battery is fully charged. The chair can be raised and lowered while charging. This regards electric chairs delivered from w. 11 2013 or earlier delivered upgraded chairs.

PLEASE NOTE!

Charging the battery is particularly important for those chairs which have **electric brake and electric tilt**, because these functions require high battery capacity to work and to not lose function. Avoid this by **charging once a day**. When replacing battery (**model designation: FGV 20721 12V 7.2Ah**), take care that the plus battery cable is connected to the plus pole of the battery, and the minus cable to the minus pole. If the chair's electric functions stop working, this is most probably due to a blown fuse. Check the fuses in the fuse holders which are located under the seat on the flex between the battery and the stand. Replace the blown fuse with a new 25A fuse.

Pay attention to the following when handling batteries:

- Never short-circuit the battery.
- Do not throw onto fires.
- Do not bump the battery.
- If you come into contact with battery acid, rinse with water for 15 min. Contact a doctor.
- Dead batteries must be handed in to recycling stations.

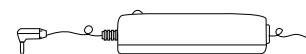
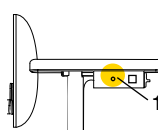

Charger art.no 802289